



Spritzgiessautomaten

## Innovative into the Future – BOY-Injectioneering



---

Insert moulding machine **BOY 60 E VV**

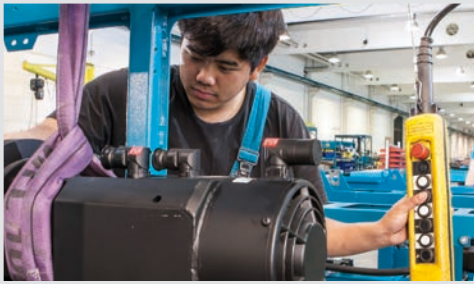

“Heart” of the insert moulding machine:  
The efficient servo-motor pump drive



Six-axis articulated robot integrated  
space-saving on the machine table

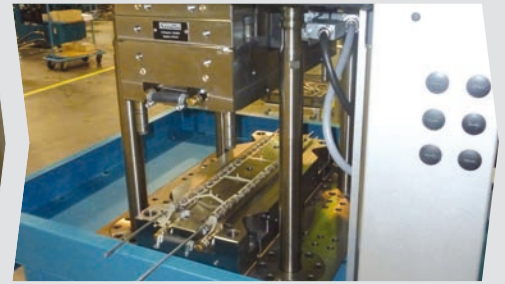

“Collar” around the fixed platen for end-  
less production of distance pieces

- Largest, four-tie bar insert moulding machine
- Ergonomically favourable table height of 975 mm
- **Optimum accessibility** to the mould area from all four sides
- Favourable machine hour rates
- Energy-efficient **servo-motor pump drive**
- Optionally with high wear-resistant and energy-efficient **EconPlast** technology

With the development of the BOY 60 E VV insert moulding machine, BOY tops off its machine programme with a universal insert moulding machine. Compact dimensions and ample space on the machine frame for peripheral and optional equipment ensure optimum integration possibilities for automation systems.



Generous distances between tie bars furthermore offer enough space for mounting large and multi-cavity moulds. Large-volume insert mouldings with total seven different screw diameters are therefore possible without any problems.

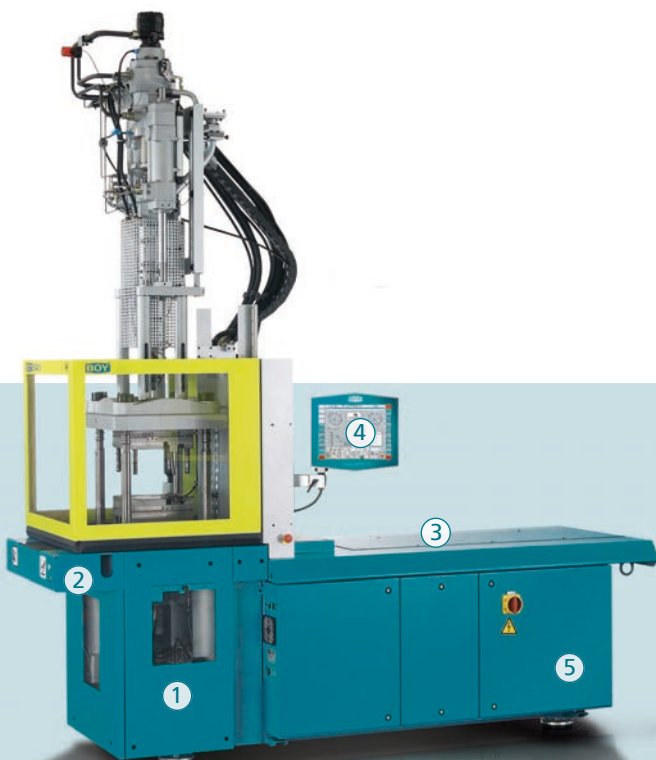

- 1 The machine design features the best ergonomics and efficient operation.
- 2 The fixed lower platen is characteristic for all BOY insert moulding machines.
- 3 Free machine table for integration of automation equipment. (higher injection speed)
- 4 Optimum control technology with intuitive operation concept.
- 5 Robust machine design with integrated oil tank.

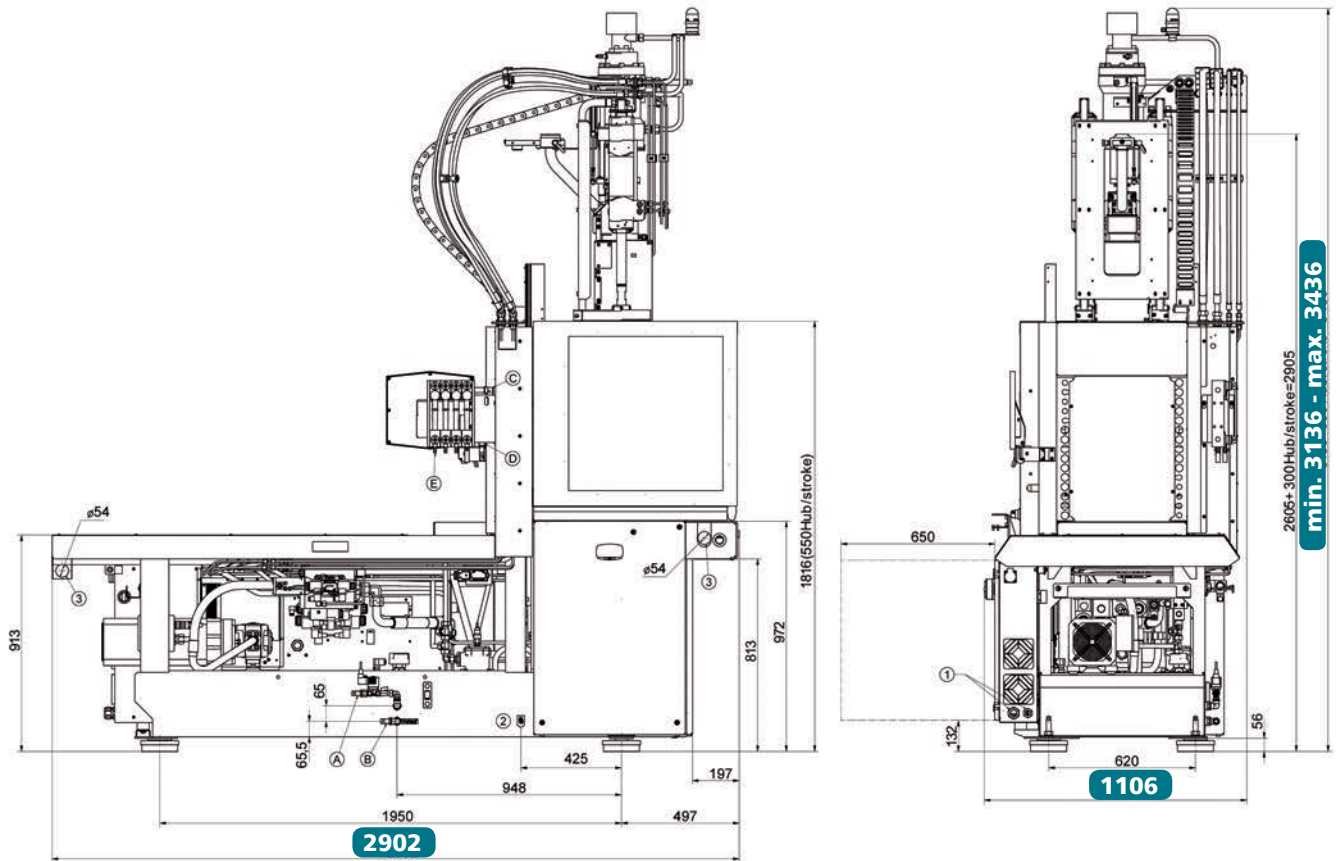

## Technical Data – standard version<sup>1)</sup>

### Injection unit for processing thermoplastics

### SP 215 (Standard)

	mm	28	32	38	42
Screw diameter	mm	28	32	38	42
Screw- L/D-ratio		22.7	20	16.7	15
Max. stroke volume (theoretical)	cm <sup>3</sup>	76.9	100.5	141.8	173.2
Max. shot weight in PS (theoretical)	g	70.0	91.4	129.0	157.6
Injection force	kN	172	172	172	172
Injection flow (theoretical)	g/s	84	110	155	189
Max. spec. injection pressure	bar	2798	2142	1519	1244
Max. screw stroke	mm	125	125	125	125
Nozzle force / contact pressure	kN	66	66	66	66
Nozzle retraction stroke	mm	215	215	215	215
Screw torque	Nm	390 <sup>2</sup> / 490 <sup>3</sup>	390 <sup>2</sup> / 490 <sup>3</sup>	390 <sup>2</sup> / 490 <sup>3</sup>	390 <sup>2</sup> / 490 <sup>3</sup>
Screw speed (infinitely variable)	U / min.	410 <sup>2</sup> / 325 <sup>3</sup>	410 <sup>2</sup> / 325 <sup>3</sup>	410 <sup>2</sup> / 325 <sup>3</sup>	410 <sup>2</sup> / 325 <sup>3</sup>
Screw pulback force	kN	29.7	29.7	29.7	29.7
Heating power (nozzle + cylinder)	W	7700	7700	7700	7700
Hopper capacity	litre	–	–	–	–

### Clamping unit

	kN	600	600	600	600
Clamping force	kN	600	600	600	600
Distance between tie bars	mm (h x v)	360 x 335	360 x 335	360 x 335	360 x 335
Max. daylight between platen	mm	550 <sup>4</sup>	550 <sup>4</sup>	550 <sup>4</sup>	550 <sup>4</sup>
Max. opening stroke (adjustable)	mm	300	300	300	300
Min. mould height	mm	250 <sup>4</sup>	250 <sup>4</sup>	250 <sup>4</sup>	250 <sup>4</sup>
Max. mould weight on moveable clamping side	kg	400	400	400	400
Mould opening force	kN	38	38	38	38
Mould closing force	kN	24.4	24.4	24.4	24.4
Ejector stroke (max.)	mm	80 (130)	80 (130)	80 (130)	80 (130)
Ejector force pushing / pulling	kN	20.4 / 13.5	20.4 / 13.5	20.4 / 13.5	20.4 / 13.5

### General

	kW	11 / 18.7 (400 V)	11 / 18.7 (400 V)	11 / 18.7 (400 V)	11 / 18.7 (400 V)
Installed driving power / total power	kW	11 / 18.7 (400 V)	11 / 18.7 (400 V)	11 / 18.7 (400 V)	11 / 18.7 (400 V)
Duration of the dry cycle (EUROMAP 6)	s – mm	1.9 – 252	1.9 – 252	1.9 – 252	1.9 – 252
Hydraulic system pressure	bar	195	195	195	195
Oil tank capacity	litre	200	200	200	200

### Dimensiones and weights

	mm / m <sup>2</sup>	2902 x 1106 x 3136 <sup>5</sup> / 3.21
Dimensions (LxWxH) / Footprint	mm / m <sup>2</sup>	2902 x 1106 x 3136 <sup>5</sup> / 3.21
Total weight net (without oil)	kg	2520
Total weight gross (pallet & foil / wooden case)	kg	2620 / 2940
Transport dimensions / case (LxWxH) approx.	m	3.1 x 1.35 x 2.5 / 3.1 x 1.35 x 2.25

1) more injection units see Technical Data and Equipment

2) hydraulic motor with stroke volume 162 cm<sup>3</sup>

3) hydraulic motor with stroke volume 204 cm<sup>3</sup>

4) optional 100 mm larger

5) max. 3436 mm



Servo-Drive



Procan ALPHA®



Technology

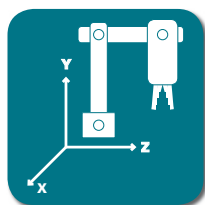

Automation

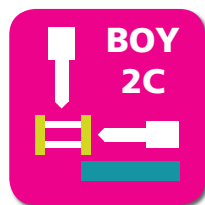

Multi Component

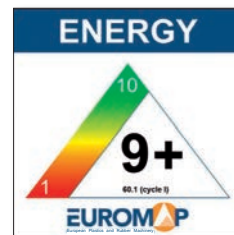

The specified efficiency classification is achievable depending on the respective machine equipment.

## Equipment

### Injection unit

Pivoting injection unit	-
Preset screw speed values with ramping transition	■
Cold start protection	■
Number of set points of injection speed	8
Number of set points of injection pressure	2
Start of holding pressure dependent on hydraulic pressure, stroke and time	■
Start of holding pressure, cavity pressure-dependent	□
Number of set points of holding pressure	8
Production monitoring at start of holding pressure	■
Closed loop control for the complete injection profile and back pressure	■
Control for intrusion-injection	■
PID microprocessor-controlled heating zones for cylinder + nozzle set and temp. display	5
Hydraulically actuated needle shut-off nozzle (pneumatic for XS-LSR)	○
Slide-away for quick material change (25 / 35 / 55 VV / 35 HV / 2C M / L without hopper)	■
Automatic material loader / feeder	□
Adjustable nozzle force	■
Delayed nozzle retraction	■
Servo-electric screw drive (separate feed line required)	○
High wear-resistant plasticizing units	○
High wear-resistant EconPlast unit	○
Speed injection	-

### Clamping unit

Reduced mould height by 50 mm	□
Moving platen support to improve the precision when using large moulds	-
Number of set points of mould closing speed / opening speed	8/8
Number of reopening attempts after mould closing	■
Hydr. ejector with dig. adjustable pressure, speed, position + no. of strokes, intermediate stop position	■
Hydraulic ejector with adjustable stroke 80 mm	■
Hydraulic ejector with adjustable stroke 130 mm	-
Hydraulic ejector with adjustable stroke 150 mm and 42,7 kN force	-
Hydraulic unscrewing device, one or two directions of rotation with intermediate stop	-
Hydraulic unscrewing device, two directions, proportional valve and pulse generator	-
Core pull control with 4/3 way directional control valve and freely selectable operational programmes	□
Injection compression (coining) and breathing with mould degassing control	□
Hydraulic guard safety device	■
Self adjusting mechanical drop bar safety system with electronic monitor	■
Safety gate for handling devices	-
Electronically operated safety gate	-
Selection flap	-
Air ejection	□
Mould lifting crane	-
Simultaneous ejector movement (with double pump)	-
Integrated sprue picker	-

### Electronics

USB interface for access and data exchange	■
Interface kit: Serial/Temperature device, USB/Printer and Ethernet	□
OPC interface	□
4 freely programmable inputs/outputs	□
Piece counter	■
Preselect cycle counter with auto shut-off	■
Grounded socket outlet 230 V ~ / 10 A (alternatively can be switched off)	■(□)
CEE socket outlet 400 V ~ / 16 A (alternatively can be switched off)	- (-)
Socket distributor 400 V ~ / 230 V ~ switched (separate feed line required)	□
Energy distributor with four fixed connections, up to 5 x 400 V CEE + 3 x 230 V (sockets can be switched off optionally). Standard supply 125 A / 5 x 50 mm²	□
Switch cabinet ventilation	■
Standardized interface for handling units (EUROMAP 67)	□
Separate feeder (heating and motor current)	○
7-day timer	■
Additional temperature control	□
Brush control	□
Connector for safety switch to inhibit mould closing	□
Integrated hot runner control, 8/16-fold (separate feed line required)	□
Air conditioning unit for control cabinet	□
Alarm signal with sound	□

### Hydraulics

Electronically controlled variable pump	-
Servo-motor pump drive (Servo-drive)	■
Oil preheating circuit automatic	■
Oil temperature gauge / Controlled oil cooling / Oil level indicator	■
Oil level and temperature monitoring	■
Optical oil filter contamination indicator	-
Proportional action valve for the clamping unit	-
Proportional valve with stroke feedback and positioning action for clamp unit	■

### General

Cooling water distributor with electric shut-off valve for injection mould	○
Temperature control for feed throat	□
6- / 8-zone water distributor	○
Tool kit	□
Spare parts package	□
Oil filling	□
Anti-vibration mounts	■

■ standard    ○ alternatively    □ optional    - not available

You would like to learn more about this BOY injection moulding machine?



Data and Equipment (complete overview)



Competence brochure



### Dr. Boy GmbH & Co. KG

Industriegebiet Neustadt / Wied  
Neschener Str. 6  
53577 Neustadt-Ferndal  
Germany

Phone: +49 (0)2683 307-0  
Fax: +49 (0)2683 307-4555  
E-Mail: info@dr-boy.de  
Internet: www.dr-boy.de



BOY-APP  
free of charge at  
http://app.dr-boy.de

