



Spritzgiessautomaten

Innovative into the Future – BOY-Injectioneering



Insert moulding machines **BOY 35 E VV**
BOY 35 E VH



Injection unit for 2C injection moulding tightly mounted on the machine table

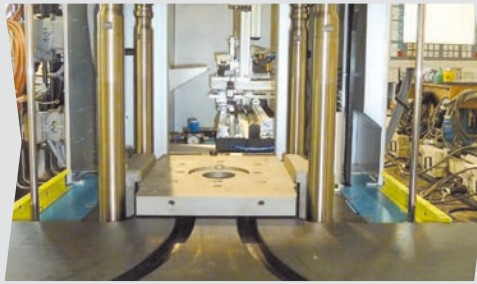

Y-table with curved tracks and integrated automation on the machine table

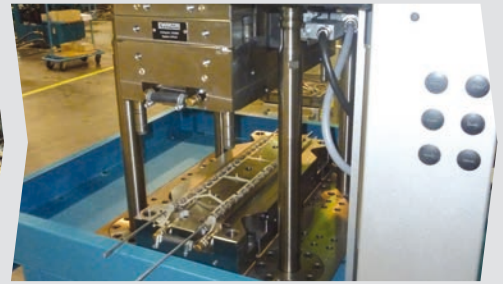

Continuous production of distance pieces of saw chains

- **Four-tie bar** insert moulding machine
- Fixed lower platen, a shifting of the inserted parts is excluded
- User-friendly automation possibilities (e.g. with Y-table, robots, light barriers, etc.)
- **Speed injection** with injection unit 16 and unit 45 (higher injection speed)
- Processing of thermoplastic material, thermoset, PVC, elastomer, silicone (LSR), MIM, Hotmelt, etc.

The basic concept of the 35 E V is quiet similar to the BOY 35 E horizontal injection moulding machine - merely the injection and clamping unit were **arranged vertically** by a 90° rotation. The lower platen **is fixed**. Therefore, a shifting of the insert parts during mould closing is excluded.

Shot weights of up to 69.5 g (PS) for highly precise applications, compact dimensions, **ample space** for peripheral equipment on the machine frame, as well as the possibility to also use smaller injection units make the BOY 35 E VV an ideal solution for **fully automatic over-moulding** of insert parts.

User-friendly automation possibilities (e.g. with Y-tables, robots, light barriers, etc.)

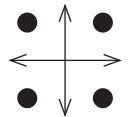

Injection into the parting line – no problem with the **BOY 35 E HV**. Especially in this market segment, BOY has worldwide a very big market share. With horizontal arranged injection unit and vertically clamping unit, injection of the materials is done into the parting line of the mould. Thus, injection points on decor surfaces can be prevented. A complex and expensive hot runner technique is not required; the production of sprues can be avoided.

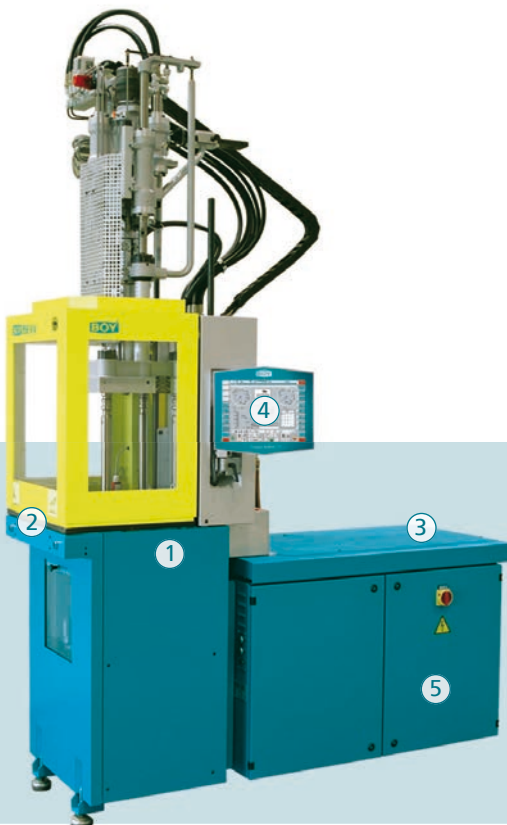

- 1 The machine design features the best ergonomics and efficient operation.
- 2 Characteristic for all BOY insert moulding machines is the fixed lower platen.
- 3 Free machine table for integration of automation equipment. (higher injection speed)
- 4 Optimum control technology with intuitive operation concept.
- 5 Robust machine design with integrated oil tank.

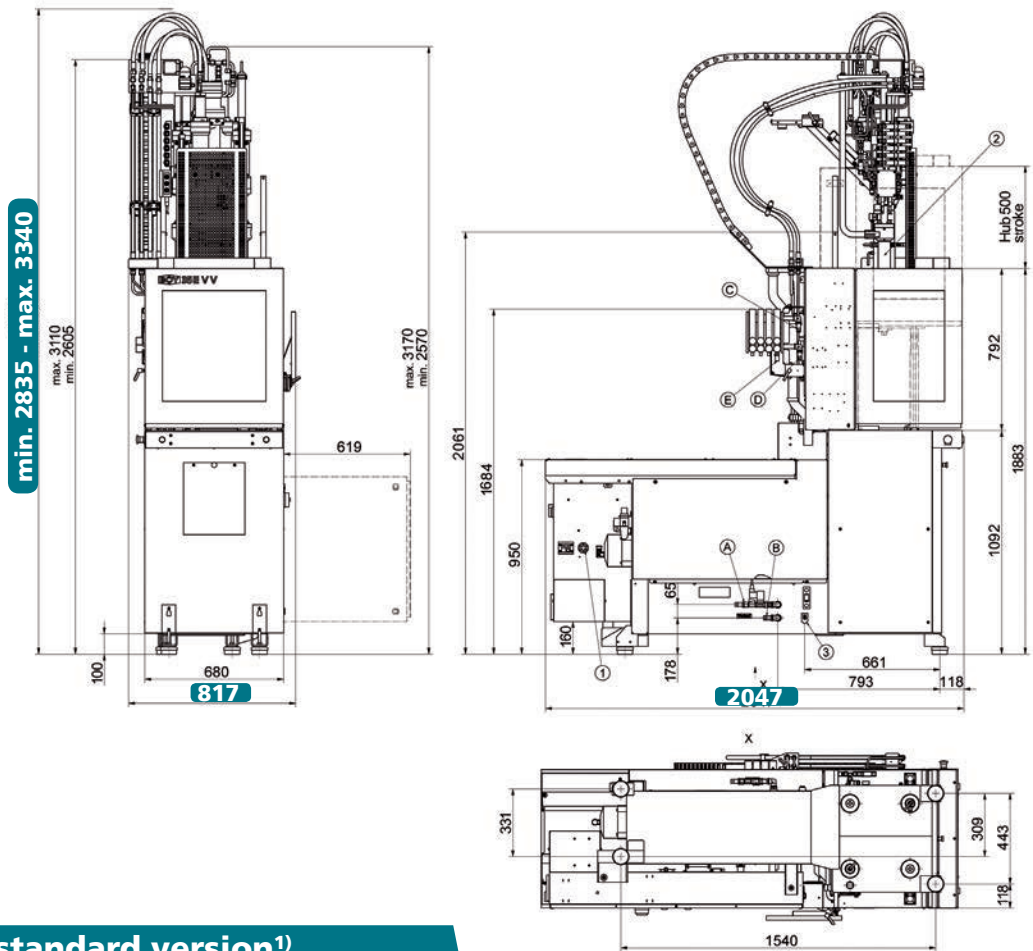

Technical Data – standard version¹⁾

Injection unit for processing thermoplastics

SP 96 (Standard)

Screw diameter	mm	24	28	32
Screw- L/D-ratio		22	18.6	16.3
Max. stroke volume (theoretical)	cm ³	43	58.5	76.5
Max. shot weight in PS (theoretical)	g	39.1	53.2	69.5
Injection force	kN	101	101	101
Injection flow (theoretical)	g/s	68.7	93.5	122.2
Max. spec. injection pressure	bar	2231	1639	1255
Max. screw stroke	mm	95	95	95
Nozzle force / contact pressure	kN	48 / 24 ⁵	48 / 24 ⁵	48 24 ⁵
Nozzle retraction stroke	mm	205	205	205
Screw torque	Nm	180 ² / 290 ³	180 ² / 290 ³	180 ² / 290 ³
Screw speed (infinitely variable)	U / min.	10-250 ³ / 10-400 ²	10-250 ³ / 10-400 ²	10-250 ³ / 10-400 ²
Screw pulback force	kN	44	44	44
Heating power (nozzle + cylinder)	W	5800	5800	5800
Hopper capacity	litre	- / 20 ⁵	- / 20 ⁵	- / 20 ⁵

Clamping unit

Clamping force	kN	350	350	350
Distance between tie bars	mm (h x v)	280 x 254	280 x 254	280 x 254
Max. daylight between platen	mm	500 ⁶	500 ⁶	500 ⁶
Max. opening stroke (adjustable)	mm	300	300	300
Min. mould height	mm	200 ⁶	200 ⁶	200 ⁶
Max. mould weight on moveable clamping side	kg	220	220	220
Mould opening force	kN	29.5	29.5	29.5
Mould closing force	kN	21.4	21.4	21.4
Ejector stroke (max.)	mm	80 (130) (150)		
Ejector force pushing / pulling	kN	23.8 / 15.8 (23.8 / 15.8) (49.9 / 35.0)		

General

Installed driving power / total power	kW	7.4 / 13.2 (400 V)	7.4 / 13.2 (400 V)	7.4 / 13.2 (400 V)
Duration of the dry cycle (EUROMAP 6)	s – mm	1.5 – 196	1.5 – 196	1.5 – 196
Hydraulic system pressure	bar	210	210	210
Oil tank capacity	litre	65	65	65

Dimensiones and weights

BOY 35 E VV

BOY 35 E VH

Dimensions (LxWxH) / Footprint	mm / m ²	2047 x 817 x 2835 ⁴ / 1.67	2047 x 802 x 2061 ⁷ / 1.64
Total weight net (without oil)	kg	1420	1450
Total weight gross (pallet & foil / wooden case)	kg	1495 / 1740	1525 / 1770
Transport dimensions / case (LxWxH) approx.	m	2.3 x 1.2 x 2.3 / 2.3 x 1.2 x 2.25	2.3 x 1.2 x 2.3 / 2.3 x 1.2 x 2.25



Servo-Drive

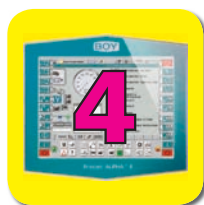

Procan ALPHA®



Technology

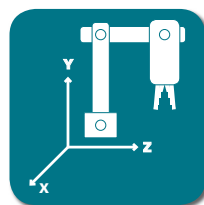

Automation

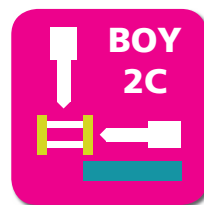

Multi Component

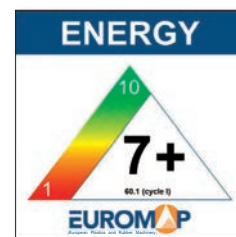

The specified efficiency classification is achievable depending on the respective machine equipment.

Equipment

Injection unit

Pivoting injection unit	-
Preset screw speed values with ramping transition	■
Cold start protection	■
Number of set points of injection speed	8
Number of set points of injection pressure	2
Start of holding pressure dependent on hydraulic pressure, stroke and time	■
Start of holding pressure, cavity pressure-dependent	□
Number of set points of holding pressure	8
Production monitoring at start of holding pressure	■
Closed loop control for the complete injection profile and back pressure	■
Control for intrusion-injection	■
PID microprocessor-controlled heating zones for cylinder + nozzle set and temp. display	5
Hydraulically actuated needle shut-off nozzle (pneumatic for XS-LSR)	○
Slide-away for quick material change (25 / 35 / 55 VV / 35 HV / 2C M / L without hopper)	■
Automatic material loader / feeder	□
Adjustable nozzle force	■
Delayed nozzle retraction	■
Servo-electric screw drive (separate feed line required)	○
High wear-resistant plasticizing units	○
High wear-resistant EconPlast unit	○
Speed injection	○

Clamping unit

Reduced mould height by 50 mm	□
Moving platen support to improve the precision when using large moulds	-
Number of set points of mould closing speed / opening speed	8/8
Number of reopening attempts after mould closing	■
Hydr. ejector with dig. adjustable pressure, speed, position + no. of strokes, intermediate stop position	■
Hydraulic ejector with adjustable stroke 80 mm	■
Hydraulic ejector with adjustable stroke 130 mm	○
Hydraulic ejector with adjustable stroke 150 mm and 42,7 kN force	-
Hydraulic unscrewing device, one or two directions of rotation with intermediate stop	-
Hydraulic unscrewing device, two directions, proportional valve and pulse generator	-
Core pull control with 4/3 way directional control valve and freely selectable operational programmes	□
Injection compression (coining) and breathing with mould degassing control	□
Hydraulic guard safety device	■
Self adjusting mechanical drop bar safety system with electronic monitor	■
Safety gate for handling devices	-
Electronically operated safety gate	-
Selection flap	-
Air ejection	□
Mould lifting crane	-
Simultaneous ejector movement (with double pump)	-
Integrated sprue picker	-

Electronics

USB interface for access and data exchange	■
Interface kit: Serial/Temperature device, USB/Printer and Ethernet	□
OPC interface	□
4 freely programmable inputs/outputs	□
Piece counter	■
Preselect cycle counter with auto shut-off	■
Grounded socket outlet 230 V ~ / 10 A (alternatively can be switched off)	■(□)
CEE socket outlet 400 V ~ / 16 A (alternatively can be switched off)	□(□)
Socket distributor 400 V ~ / 230 V ~ switched (separate feed line required)	□
Energy distributor with four fixed connections, up to 5 x 400 V CEE + 3 x 230 V (sockets can be switched off optionally). Standard supply 125 A / 5 x 50 mm²	□
Switch cabinet ventilation	■
Standardized interface for handling units (EUROMAP 67)	□
Separate feeder (heating and motor current)	○
7-day timer	■
Additional temperature control	□
Brush control	□
Connector for safety switch to inhibit mould closing	□
Integrated hot runner control, 8/16-fold (separate feed line required)	□
Air conditioning unit for control cabinet	□
Alarm signal with sound	□

Hydraulics

Electronically controlled variable pump	-
Servo-motor pump drive (Servo-drive)	■
Oil preheating circuit automatic	■
Oil temperature gauge / Controlled oil cooling / Oil level indicator	■
Oil level and temperature monitoring	■
Optical oil filter contamination indicator	-
Proportional action valve for the clamping unit	-
Proportional valve with stroke feedback and positioning action for clamp unit	-

General

Cooling water distributor with electric shut-off valve for injection mould	○
Temperature control for feed throat	□
6- / 8-zone water distributor	○
Tool kit	□
Spare parts package	□
Oil filling	□
Anti-vibration mounts	■

■ standard ○ alternatively □ optional - not available

You would like to learn more about this BOY injection moulding machine?



Data and Equipment (complete overview)



Competence brochure



Dr. Boy GmbH & Co. KG

Industriegebiet Neustadt / Wied
Neschener Str. 6
53577 Neustadt-Ferndal
Germany

Phone: +49 (0)2683 307-0
Fax: +49 (0)2683 307-4555
E-Mail: info@dr-boy.de
Internet: www.dr-boy.de



BOY-APP
free of charge at
http://app.dr-boy.de

